



TDA2020

LINEAR INTEGRATED CIRCUITS

NOT FOR NEW DESIGN

20W Hi-Fi AUDIO AMPLIFIER

The TDA 2020 is a monolithic integrated operational amplifier in a 14-lead quad in-line plastic package, intended for use as a low frequency class B power amplifier. Typically it provides 20W output power ($d = 1\%$) at $\pm 18V/4\Omega$; the guaranteed output power at $\pm 17V/4\Omega$ is 15W (DIN norm 45500). The TDA 2020 provides high output current (up to 3.5 A) and has very low harmonic and cross-over distortion. Further, the device incorporates an original (and patented) short circuit protection system, comprising an arrangement for automatically limiting the dissipated power so as to keep to working point of the output transistors within their safe operating area. A conventional thermal shut-down system is also included.

ABSOLUTE MAXIMUM RATINGS

V_s	Supply voltage	± 22	V
V_i	Input voltage	V_s	V
V_{i1}	Differential input voltage	± 15	V
I_o	Output peak current (internally limited)	3.5	A
P_{tot}	Power dissipation at $T_{case} \leq 75^\circ C$	25	W
T_{stg}, T_j	Storage and junction temperature	-40 to 150	$^\circ C$

ORDERING NUMBERS: TDA 2020 A82 dual in-line plastic package
 TDA 2020 A92 quad in-line plastic package
 TDA 2020 AC2 dual in-line plastic package with spacer
 TDA 2020 AD2 quad in-line plastic package with spacer

MECHANICAL DATA

Dimensions in mm

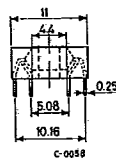
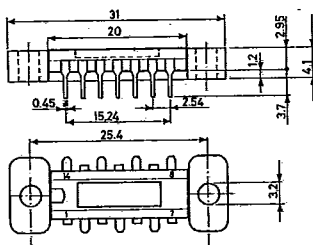
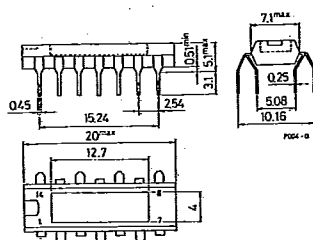



CONNECTION AND SCHEMATIC DIAGRAMS
(top view)

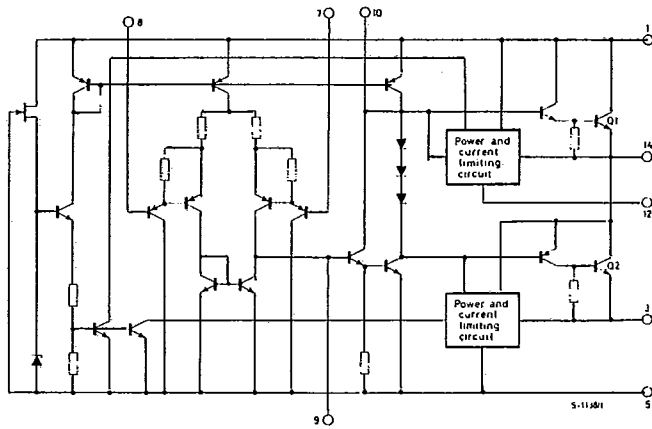
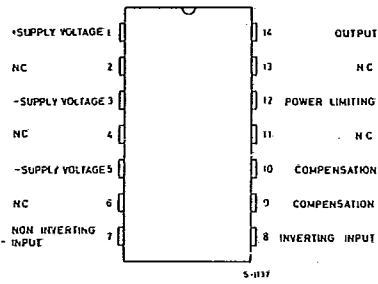

The copper slug is electrically connected to pin 5 (substrate)

TEST CIRCUIT

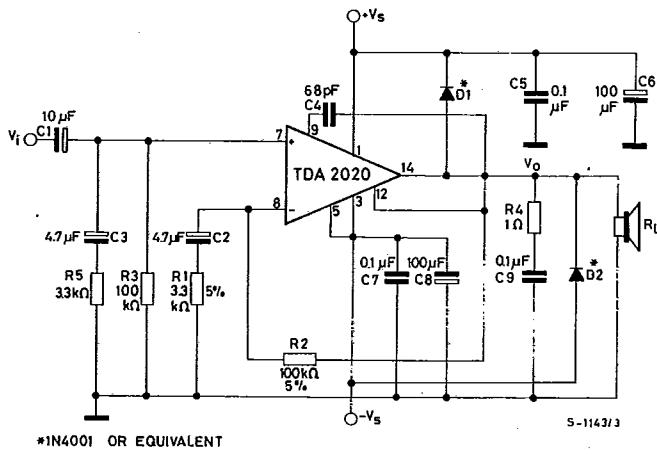

THERMAL DATA

$R_{th J-case}$	Thermal resistance junction-case	max	3	$^{\circ}C/W$
1272	G-07	560		



ELECTRICAL CHARACTERISTICS

(Refer to the test circuit, $V_s = \pm 17V$, $T_{amb} = 25^\circ C$ unless otherwise specified)

Parameter	Test conditions	Min.	Typ.	Max.	Unit
V_s	Supply voltage	± 5		± 22	V
I_d	Quiescent drain current		60		mA
I_b	Input bias current		0.15		μA
V_{os}	Input offset voltage		5		mV
I_{os}	Input offset current		0.05		μA
V_{os}	Output offset voltage		10	100	mV
P_o	Output power	$d = 1\%$ $G_v = 30 \text{ dB}$ $T_{case} \leq 70^\circ C$ $f = 40 \text{ to } 15\,000 \text{ Hz}$ $V_s = \pm 17V$ $R_L = 4 \Omega$ $V_s = \pm 18V$ $R_L = 4 \Omega$ $V_s = \pm 18V$ $R_L = 8 \Omega$	15	18.5	W
				20	
		$d = 10\%$ $G_v = 30 \text{ dB}$ $T_{case} \leq 70^\circ C$ $f = 1 \text{ kHz}$ $V_s = \pm 17V$ $R_L = 4 \Omega$ $V_s = \pm 18V$ $R_L = 8 \Omega$		24	W
				20	
V_i	Input sensitivity	$G_v = 30 \text{ dB}$ $f = 1 \text{ kHz}$ $P_o = 15 \text{ W}$ $V_s = \pm 17V$ $R_L = 4 \Omega$ $V_s = \pm 18V$ $R_L = 8 \Omega$		260	mV
				380	
B	Frequency response (-3 dB)	$R_L = 4 \Omega$ $C_4 = 68 \text{ pF}$	10 to 160 000		Hz
d	Distortion	$P_o = 150 \text{ mW to } 15W$ $R_L = 4 \Omega$ $G_v = 30 \text{ dB}$ $T_{case} \leq 70^\circ C$ $f = 1 \text{ kHz}$ $f = 40 \text{ to } 15\,000 \text{ Hz}$		0.2	%
				0.3	
		$P_o = 150 \text{ mW to } 15W$ $V_s = \pm 18V$ $R_L = 8 \Omega$ $G_v = 30 \text{ dB}$ $T_{case} \leq 70^\circ C$ $f = 1 \text{ kHz}$ $f = 40 \text{ to } 15\,000 \text{ Hz}$		0.1	%
				0.25	
R_i	Input resistance (pin 7)		5		M Ω
G_v	Voltage gain (open loop)	$R_L = 4 \Omega$ $f = 1 \text{ kHz}$	100		dB
G_v	Voltage gain (closed loop)		29.5	30	30.5



ELECTRICAL CHARACTERISTICS (continued)

Parameter	Test conditions	Min.	Typ.	Max.	Unit
e_N	Input noise voltage		4		μV
i_N	Input noise current		0.1		nA
SVR	Supply voltage rejection		50		dB
I_d	Drain current		1		A
			0.7		A
T_{sd}	Thermal shut-down junction temperature		140		$^{\circ}C$
T_{sd}	Thermal shut-down case temperature		105		$^{\circ}C$

Fig. 1 - Output power vs. supply voltage

Fig. 2 - Output power vs. supply voltage

Fig. 3 - Distortion vs. output power

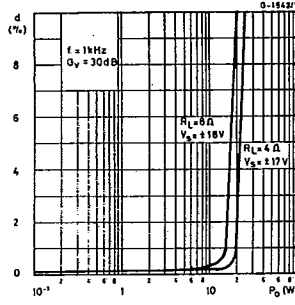
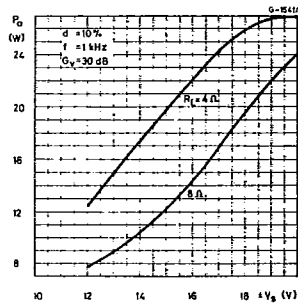
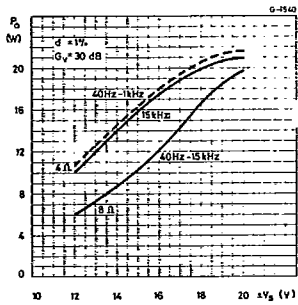

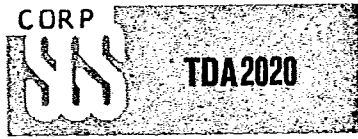

Fig. 4 - Distortion vs. output power ($R_L = 4 \Omega$)

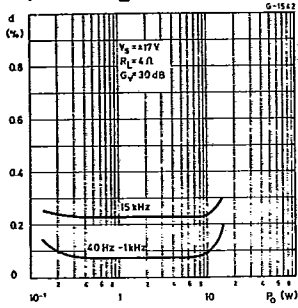

Fig. 5 - Distortion vs. output power ($R_L = 8 \Omega$)

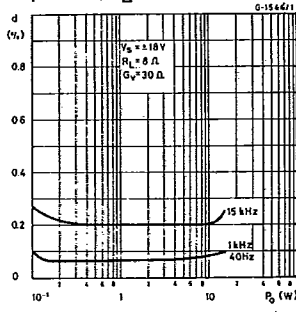

Fig. 6 - Distortion vs. frequency

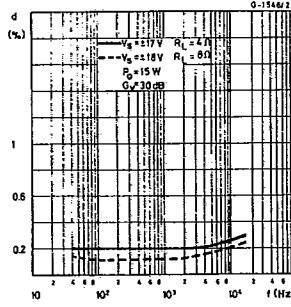

Fig. 7 - Output power vs. frequency

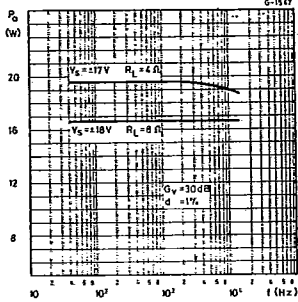

Fig. 8 - Sensitivity vs. output power ($R_L = 4 \Omega$)

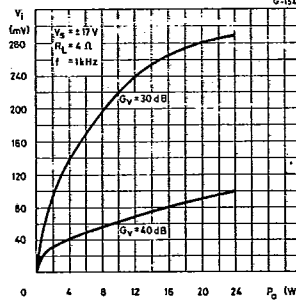

Fig. 9 - Sensitivity vs. output power ($R_L = 8 \Omega$)

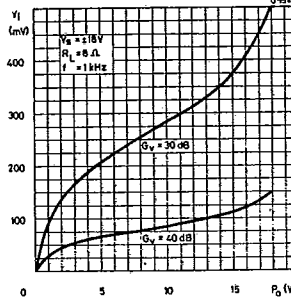

Fig. 10 - Open loop frequency response with different values of the rolloff capacitor C4

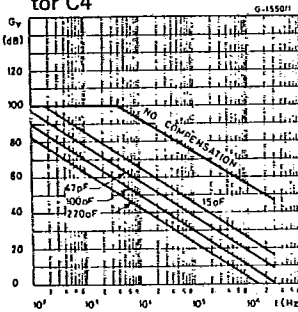

Fig. 11 - Value of C4 vs. voltage gain for different bandwidths

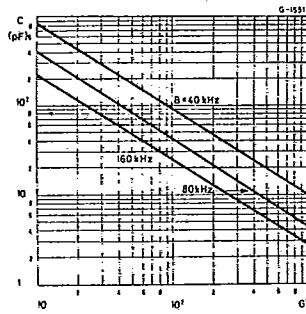
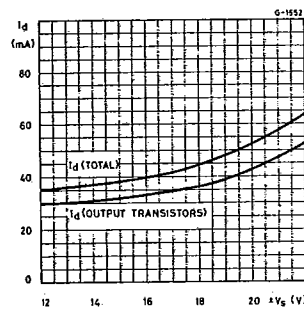

Fig. 12 - Quiescent current vs. supply voltage





T-74-05-01

Fig. 13 - Supply voltage rejection vs. voltage gain

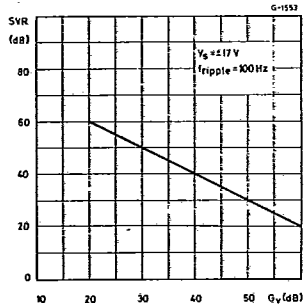

Fig. 14 - Power dissipation and efficiency vs. output power

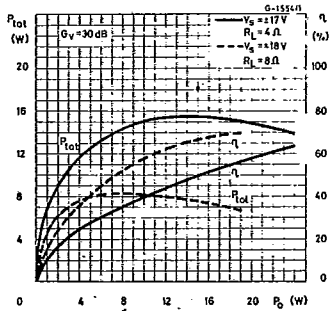
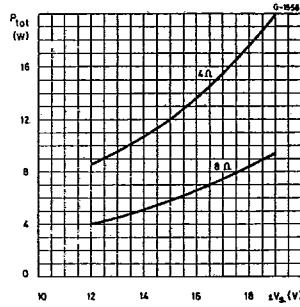
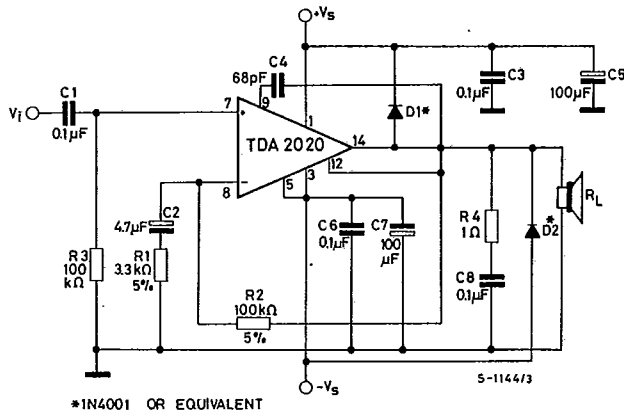

Fig. 15 - Maximum power dissipation vs. supply voltage (sine wave operation)



APPLICATION INFORMATION

Fig. 16 - Application circuit with split power supply



Copyright © Each Manufacturing Company.

All Datasheets cannot be modified without permission.

This datasheet has been download from :

www.AllDataSheet.com

100% Free DataSheet Search Site.

Free Download.

No Register.

Fast Search System.

www.AllDataSheet.com