

# LM2941/LM2941C 1A Low Dropout Adjustable Regulator

## General Description

The LM2941 positive voltage regulator features the ability to source 1A of output current with a typical dropout voltage of 0.5V and a maximum of 1V over the entire temperature range. Furthermore, a quiescent current reduction circuit has been included which reduces the ground pin current when the differential between the input voltage and the output voltage exceeds approximately 3V. The quiescent current with 1A of output current and an input-output differential of 5V is therefore only 30 mA. Higher quiescent currents only exist when the regulator is in the dropout mode ( $V_{IN} - V_{OUT} \leq 3V$ ).

Designed also for vehicular applications, the LM2941 and all regulated circuitry are protected from reverse battery installations or two-battery jumps. During line transients, such as load dump when the input voltage can momentarily exceed the specified maximum operating voltage, the regu-

lator will automatically shut down to protect both the internal circuits and the load. Familiar regulator features such as short circuit and thermal overload protection are also provided.

## Features

- Output voltage adjustable from 5V to 20V
- Dropout voltage typically 0.5V @  $I_O = 1A$
- Output current in excess of 1A
- Trimmed reference voltage
- Reverse battery protection
- Internal short circuit current limit
- Mirror image insertion protection
- P+ Product Enhancement tested
- TTL, CMOS compatible ON/OFF switch

## Connection Diagram and Ordering Information

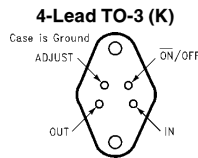

TL/H/8823-7

**Bottom View**

Order Number LM2941K/883  
See NS Package Number K04A

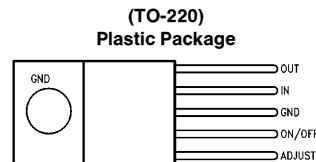

TL/H/8823-2

**Front View**

Order Number LM2941T or LM2941CT  
See NS Package Number T05A

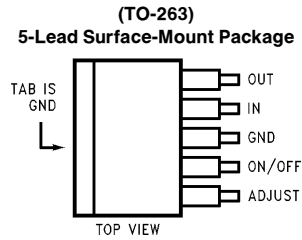

TL/H/8823-8

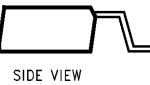

TL/H/8823-9

Order Number LM2941S or LM2941CS  
See NS Package Number TS5B

## Absolute Maximum Ratings (Note 1)

If Military/Aerospace specified devices are required, please contact the National Semiconductor Sales Office/Distributors for availability and specifications.

Input Voltage (Survival Voltage, $\leq 100$ ms)	60V
LM2941K, LM2941T, LM2941S	45V
LM2941CT, LM2941CS	45V
Internal Power Dissipation (Note 3)	Internally Limited
Maximum Junction Temperature	150°C
Storage Temperature Range	$-65^{\circ}\text{C} \leq T_J \leq +150^{\circ}\text{C}$

Lead Temperature (Soldering, 10 seconds)	
TO-3 (K) Package	300°C
TO-220 (T) Package	260°C
TO-263 (S) Package	260°C

ESD susceptibility to be determined.

## Operating Ratings

Maximum Input Voltage	26V
Temperature Range	
LM2941K	$-55^{\circ}\text{C} \leq T_J \leq 150^{\circ}\text{C}$
LM2941T	$-40^{\circ}\text{C} \leq T_J \leq 125^{\circ}\text{C}$
LM2941CT	$-0^{\circ}\text{C} \leq T_J \leq 125^{\circ}\text{C}$
LM2941S	$-40^{\circ}\text{C} \leq T_J \leq 125^{\circ}\text{C}$
LM2941CS	$-0^{\circ}\text{C} \leq T_J \leq 125^{\circ}\text{C}$

## Electrical Characteristics—LM2941K, LM2941T, LM2941S

$5\text{V} \leq V_O \leq 20\text{V}$ ,  $V_{IN} = V_O + 5\text{V}$ ,  $C_O = 22\ \mu\text{F}$ , unless otherwise specified. Specifications in standard typeface apply for  $T_J = 25^{\circ}\text{C}$ , while those in **boldface type** apply over the full **Operating Temperature Range**.

Parameter	Conditions	Typ	LM2941K Limit (Notes 2, 4)	LM2941T LM2941S Limit (Note 5)	Units (Limits)
Reference Voltage	$5\text{ mA} \leq I_O \leq 1\text{ A}$ (Note 6)	1.275	1.237/ <b>1.211</b> 1.313/ <b>1.339</b>	1.237/ <b>1.211</b> 1.313/ <b>1.339</b>	V(min) V(max)
Line Regulation	$V_O + 2\text{V} \leq V_{IN} \leq 26\text{V}$ , $I_O = 5\text{ mA}$	4	10/ <b>10</b>	10/ <b>10</b>	mV/V(max)
Load Regulation	$50\text{ mA} \leq I_O \leq 1\text{ A}$	7	10/ <b>10</b>	10/ <b>10</b>	mV/V(max)
Output Impedance	100 mADC and 20 mArms $f_O = 120\text{ Hz}$	7			m $\Omega$ /V
Quiescent Current	$V_O + 2\text{V} \leq V_{IN} < 26\text{V}$ , $I_O = 5\text{ mA}$	10	15/ <b>20</b>	15/ <b>20</b>	mA(max)
	$V_{IN} = V_O + 5\text{V}$ , $I_O = 1\text{ A}$	30	45/ <b>60</b>	45/ <b>60</b>	mA(max)
RMS Output Noise, % of $V_{OUT}$	10 Hz–100 kHz $I_O = 5\text{ mA}$	0.003			%
Ripple Rejection	$f_O = 120\text{ Hz}$ , 1 Vrms, $I_L = 100\text{ mA}$	0.005	0.02/ <b>0.04</b>	0.02/ <b>0.04</b>	%/V(max)
Long Term Stability		0.4			%/1000 Hr
Dropout Voltage	$I_O = 1\text{ A}$	0.5	0.8/ <b>1.0</b>	0.8/ <b>1.0</b>	V(max)
	$I_O = 100\text{ mA}$	110	200/ <b>200</b>	200/ <b>200</b>	mV(max)
Short Circuit Current	$V_{IN\text{ max}} = 26\text{V}$ (Note 7)	1.9	1.6/ <b>1.3</b>	1.6	A(min)
Maximum Line Transient	$V_O$ max 1V above nominal $V_O$ $R_O = 100\ \Omega$ , $T \leq 100\text{ ms}$	75	60/ <b>60</b>	60/ <b>60</b>	V(min)
Maximum Operational Input Voltage		31	26/ <b>26</b>	26/ <b>26</b>	$V_{DC}$
Reverse Polarity DC Input Voltage	$R_O = 100\ \Omega$ , $V_O \geq -0.6\text{V}$	-30	-15/ <b>-15</b>	-15/ <b>-15</b>	V(min)
Reverse Polarity Transient Input Voltage	$T \leq 100\text{ ms}$ , $R_O = 100\ \Omega$	-75	-50/ <b>-50</b>	-50/ <b>-50</b>	V(min)
ON/OFF Threshold Voltage ON	$I_O \leq 1\text{ A}$	1.30	0.80/ <b>0.80</b>	0.80/ <b>0.80</b>	V(max)
ON/OFF Threshold Voltage OFF	$I_O \leq 1\text{ A}$	1.30	2.00/ <b>2.00</b>	2.00/ <b>2.00</b>	V(min)
ON/OFF Threshold Current	$V_{ON/OFF} = 2.0\text{V}$ , $I_O \leq 1\text{ A}$	50	100/ <b>300</b>	100/ <b>300</b>	$\mu\text{A}$ (max)

## Electrical Characteristics—LM2941CT, LM2941CS

$5V \leq V_O \leq 20V$ ,  $V_{IN} = V_O + 5V$ ,  $C_O = 22 \mu F$ , unless otherwise specified. Specifications in standard typeface apply for  $T_J = 25^\circ C$ , while those in **boldface type** apply over the full **Operating Temperature Range**.

Parameter	Conditions	Typ	Limit (Note 5)	Units (Limits)
Reference Voltage	$5 \text{ mA} \leq I_O \leq 1 \text{ A}$ (Note 6)	1.275	1.237/ <b>1.211</b> 1.313/ <b>1.339</b>	V(min) V(max)
Line Regulation	$V_O + 2V \leq V_{IN} \leq 26V$ , $I_O = 5 \text{ mA}$	4	10	mV/V(max)
Load Regulation	$50 \text{ mA} \leq I_O \leq 1 \text{ A}$	7	10	mV/V(max)
Output Impedance	100 mADC and 20 mArms $f_O = 120 \text{ Hz}$	7		$\text{m}\Omega/\text{V}$
Quiescent Current	$V_O + 2V \leq V_{IN} < 26V$ , $I_O = 5 \text{ mA}$	10	15	mA(max)
	$V_{IN} = V_O + 5V$ , $I_O = 1 \text{ A}$	30	45/ <b>60</b>	mA(max)
RMS Output Noise, % of $V_{OUT}$	10 Hz–100 kHz $I_O = 5 \text{ mA}$	0.003		%
Ripple Rejection	$f_O = 120 \text{ Hz}$ , 1 Vrms, $I_L = 100 \text{ mA}$	0.005	0.02	%/V(max)
Long Term Stability		0.4		%/1000 Hr
Dropout Voltage	$I_O = 1 \text{ A}$	0.5	0.8/ <b>1.0</b>	V(max)
	$I_O = 100 \text{ mA}$	110	200/ <b>200</b>	mV(max)
Short Circuit Current	$V_{IN \text{ max}} = 26V$ (Note 7)	1.9	1.6	A(min)
Maximum Line Transient	$V_O$ max 1V above nominal $V_O$ $R_O = 100\Omega$ , $T \leq 100 \text{ ms}$	55	45	V(min)
Maximum Operational Input Voltage		31	26	$V_{DC}$
Reverse Polarity DC Input Voltage	$R_O = 100\Omega$ , $V_O \geq -0.6V$	-30	-15	V(min)
Reverse Polarity Transient Input Voltage	$T \leq 100 \text{ ms}$ , $R_O = 100\Omega$	-55	-45	V(min)
ON/OFF Threshold Voltage ON	$I_O \leq 1 \text{ A}$	1.30	0.80	V(max)
ON/OFF Threshold Voltage OFF	$I_O \leq 1 \text{ A}$	1.30	2.00	V(min)
ON/OFF Threshold Current	$V_{ON/OFF} = 2.0V$ , $I_O \leq 1 \text{ A}$	50	100	$\mu\text{A}$ (max)

**Note 1:** Absolute Maximum Ratings indicate limits beyond which damage to the device may occur. Operating ratings indicate conditions for which the device is intended to be functional, but device parameter specifications may not be guaranteed under these conditions. For guaranteed specifications and test conditions, see the Electrical Characteristics.

**Note 2:** A military RETS specification available upon request. At the time of printing, the LM2941/883 RETS specification complied with the boldface limits in this column. The LM2941K/883 may also be procured to a Standard Military Drawing.

**Note 3:** The maximum power dissipation is a function of  $T_J(\text{max})$ ,  $\theta_{JA}$ , and  $T_A$ . The maximum allowable power dissipation at any ambient temperature is  $P_D = (T_J(\text{max}) - T_A)/\theta_{JA}$ . If this dissipation is exceeded, the die temperature will rise above  $150^\circ C$  and the LM2941 will go into thermal shutdown. For the LM2941T and LM2941CT, the junction-to-ambient thermal resistance ( $\theta_{JA}$ ) is  $53^\circ C/W$ , and the junction-to-case thermal resistance ( $\theta_{JC}$ ) is  $3^\circ C/W$ . For the LM2941K,  $\theta_{JA}$  is  $35^\circ C/W$  and  $\theta_{JC}$  is  $4^\circ C/W$ . The junction-to-ambient thermal resistance of the TO-263 is  $73^\circ C/W$ , and junction-to-case thermal resistance,  $\theta_{JC}$  is  $3^\circ C$ . If the TO-263 package is used, the thermal resistance can be reduced by increasing the P.C. board copper area thermally connected to the package: Using 0.5 square inches of copper area,  $\theta_{JA}$  is  $50^\circ C/W$ ; with 1 square inch of copper area,  $\theta_{JA}$  is  $37^\circ C/W$ ; and with 1.6 or more square inches of copper area,  $\theta_{JA}$  is  $32^\circ C/W$ .

**Note 4:** All limits guaranteed at room temperature (standard typeface) and at temperature extremes (boldface type). All limits are used to calculate Outgoing Quality Level, and are 100% production tested.

**Note 5:** All limits guaranteed at room temperature (standard typeface) and at temperature extremes (boldface type). All room temperature limits are 100% production tested. All limits at temperature extremes are guaranteed via correlation using standard Statistical Quality Control (SQC) methods.

**Note 6:** The output voltage range is 5V to 20V and is determined by the two external resistors, R1 and R2. See Typical Application Circuit.

**Note 7:** Output current capability will decrease with increasing temperature, but will not go below 1A at the maximum specified temperatures.

# Typical Performance Characteristics

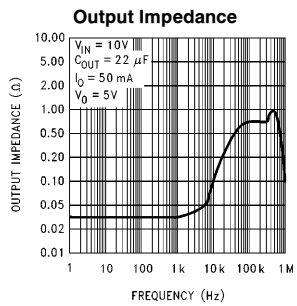
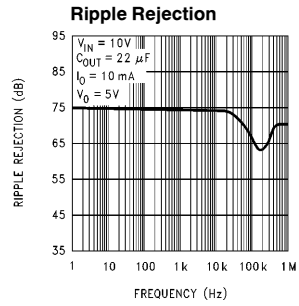
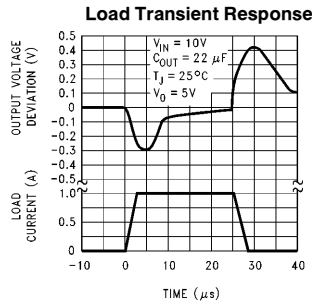
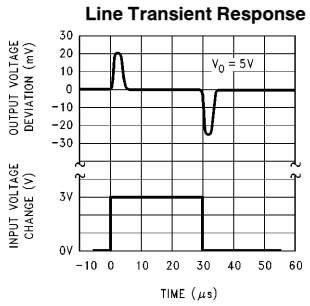
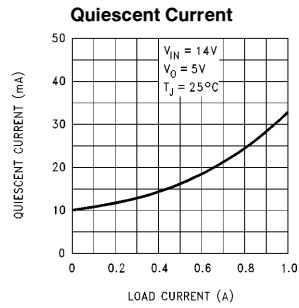
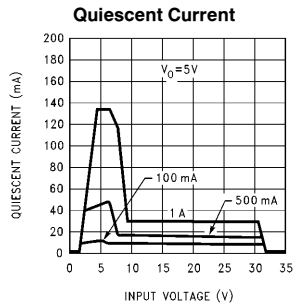
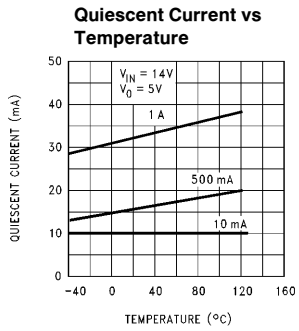
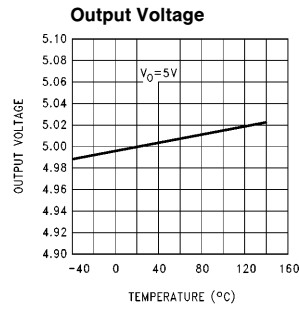
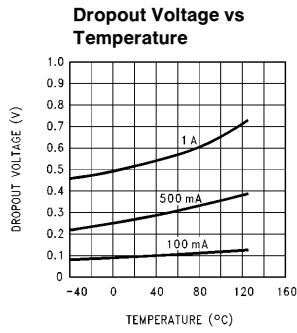
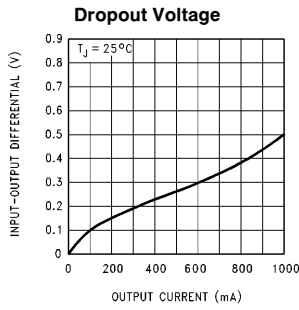

## Typical Performance Characteristics (Continued)

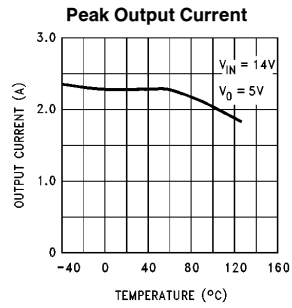
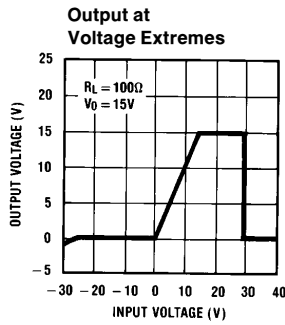
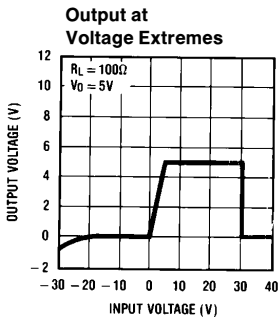
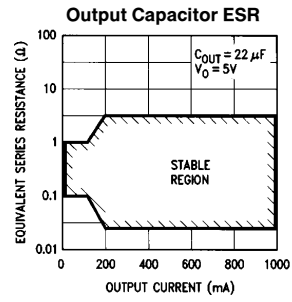
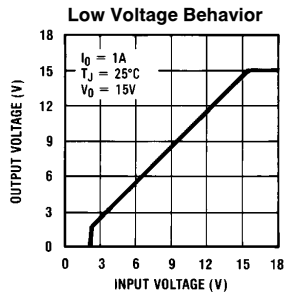
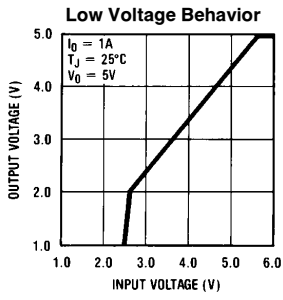

TL/H/8823-5

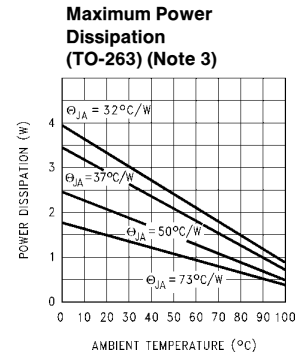
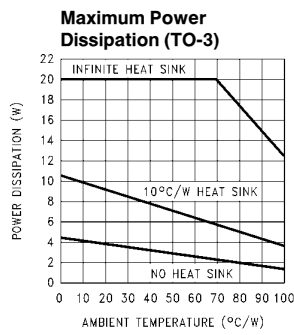
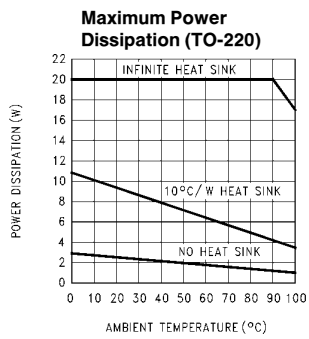

TL/H/8823-10

## Definition of Terms

**Dropout Voltage:** The input-voltage differential at which the circuit ceases to regulate against further reduction in input voltage. Measured when the output voltage has dropped 100 mV from the nominal value obtained at ( $V_{OUT} + 5V$ ) input, dropout voltage is dependent upon load current and junction temperature.

**Input Voltage:** The DC voltage applied to the input terminals with respect to ground.

**Input-Output Differential:** The voltage difference between the unregulated input voltage and the regulated output voltage for which the regulator will operate.

**Line Regulation:** The change in output voltage for a change in the input voltage. The measurement is made under conditions of low dissipation or by using pulse techniques such that the average chip temperature is not significantly affected.

**Load Regulation:** The change in output voltage for a change in load current at constant chip temperature.

**Long Term Stability:** Output voltage stability under accelerated life-test conditions after 1000 hours with maximum rated voltage and junction temperature.

**Output Noise Voltage:** The rms AC voltage at the output, with constant load and no input ripple, measured over a specified frequency range.

**Quiescent Current:** That part of the positive input current that does not contribute to the positive load current. The regulator ground lead current.

**Ripple Rejection:** The ratio of the peak-to-peak input ripple voltage to the peak-to-peak output ripple voltage.

**Temperature Stability of  $V_O$ :** The percentage change in output voltage for a thermal variation from room temperature to either temperature extreme.

## Typical Applications

### 5V to 20V Adjustable Regulator

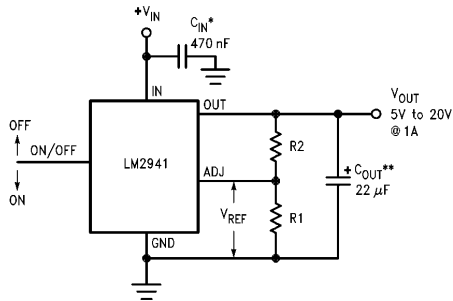

TL/H/8823-3

$$V_{OUT} = \text{Reference voltage} \times \frac{R1 + R2}{R1} \text{ where } V_{REF} = 1.275 \text{ typical}$$

$$\text{Solving for } R2: R2 = R1 \left( \frac{V_O}{V_{REF}} - 1 \right)$$

**Note:** Using 1k for R1 will ensure that the input bias current error of the adjust pin will be negligible. Do not bypass R1 or R2. This will lead to instabilities.

\*Required if regulator is located far from power supply filter.

\*\* $C_{OUT}$  must be at least 22  $\mu F$  to maintain stability. May be increased without bound to maintain regulation during transients. Locate as close as possible to the regulator. This capacitor must be rated over the same operating temperature range as the regulator and the ESR is critical; see curve.

### 1A Switch

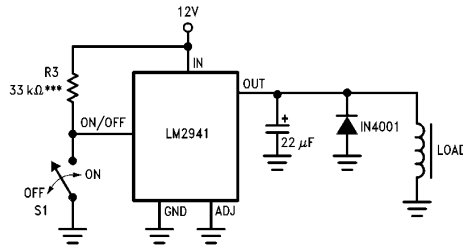

TL/H/8823-6

\*\*\*To assure shutdown, select Resistor R3 to guarantee at least 300  $\mu A$  of pull-up current when S1 is open. (Assume 2V at the ON/OFF pin.)

# Equivalent Schematic Diagram

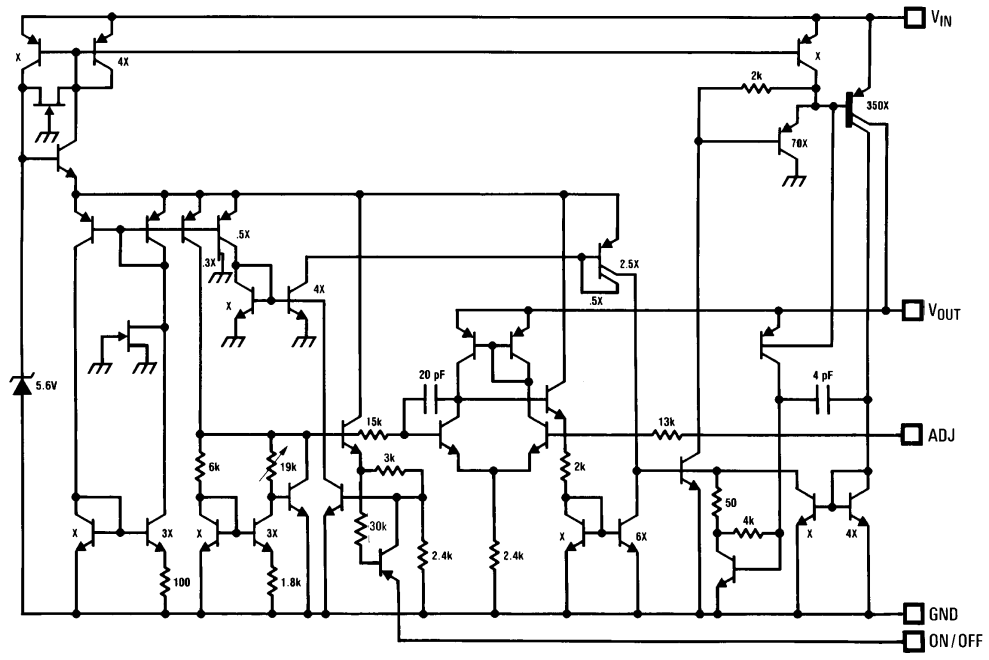

TL/H/8823-1





**Physical Dimensions** inches (millimeters)

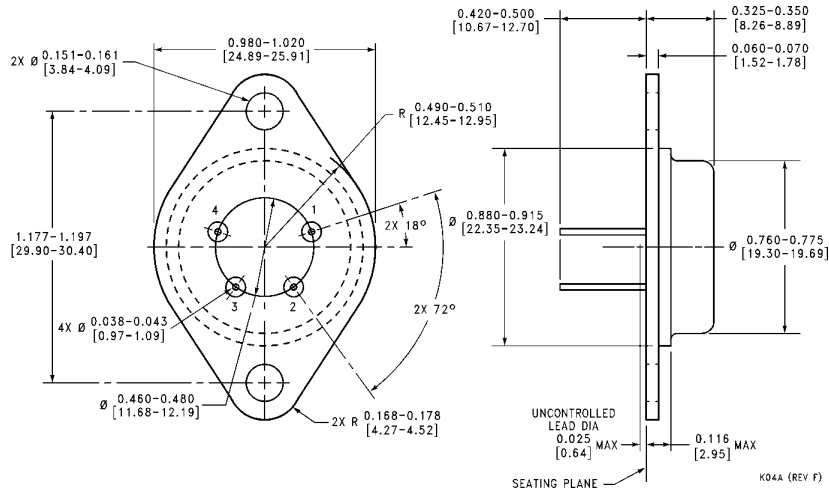

**Order Number LM2941K/883**  
**NS Package Number K04A**

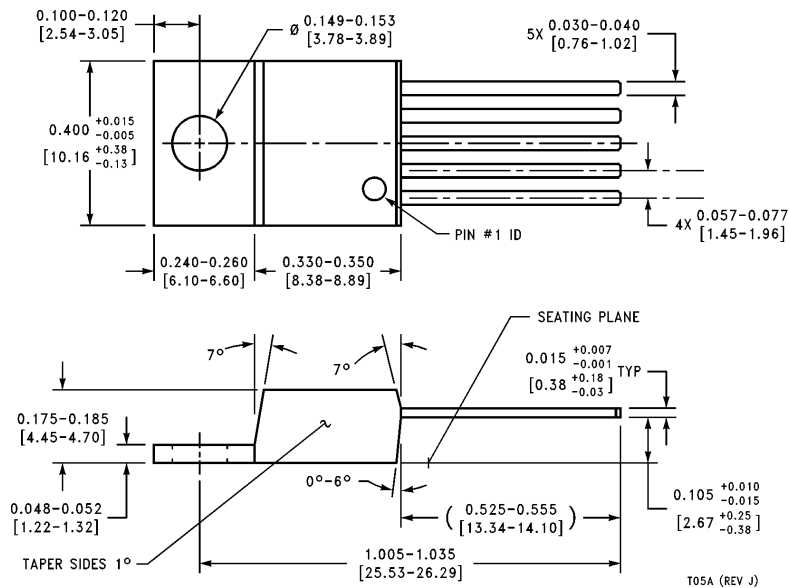

**Order Number LM2941T or LM2941CT**  
**NS Package Number T05A**

**Physical Dimensions** inches (millimeters) (Continued)

Lit. # 108022

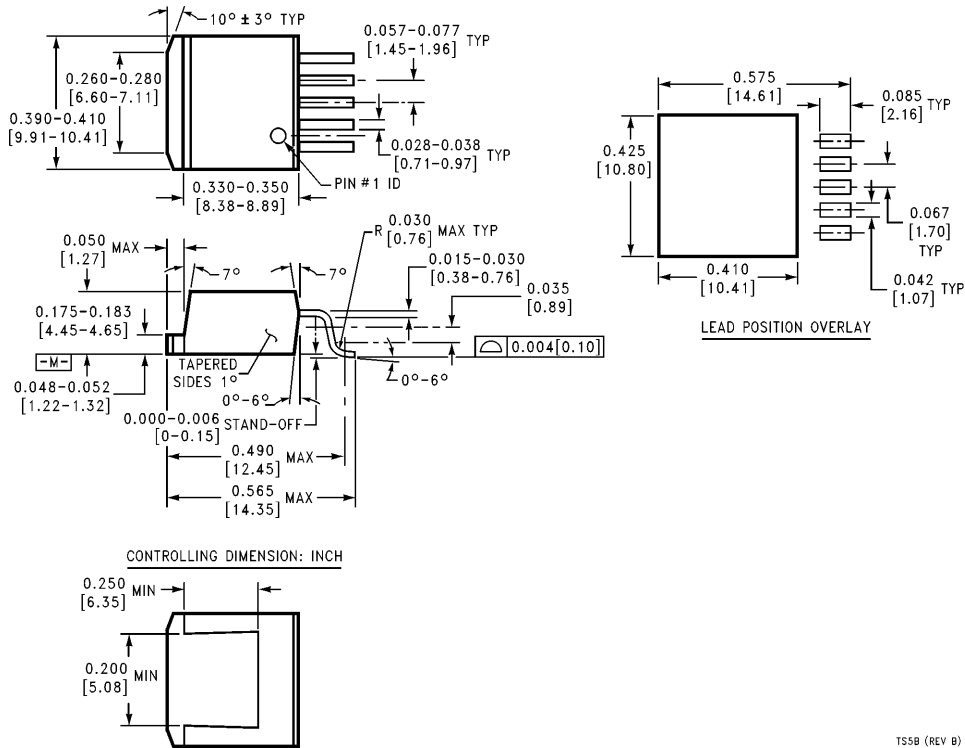

TS5B (REV B)

**TO-263 5-Lead Plastic Surface Mount Package**  
**Order Number LM2941S or LM2941CS**  
**NS Package Number TS5B**

**LIFE SUPPORT POLICY**

NATIONAL'S PRODUCTS ARE NOT AUTHORIZED FOR USE AS CRITICAL COMPONENTS IN LIFE SUPPORT DEVICES OR SYSTEMS WITHOUT THE EXPRESS WRITTEN APPROVAL OF THE PRESIDENT OF NATIONAL SEMICONDUCTOR CORPORATION. As used herein:

1. Life support devices or systems are devices or systems which, (a) are intended for surgical implant into the body, or (b) support or sustain life, and whose failure to perform, when properly used in accordance with instructions for use provided in the labeling, can be reasonably expected to result in a significant injury to the user.
2. A critical component is any component of a life support device or system whose failure to perform can be reasonably expected to cause the failure of the life support device or system, or to affect its safety or effectiveness.



**National Semiconductor Corporation**  
 2900 Semiconductor Drive  
 P.O. Box 58090  
 Santa Clara, CA 95052-8090  
 Tel: (800) 272-9959  
 TWX: (910) 339-9240

**National Semiconductor GmbH**  
 Livny-Gargan-Str. 10  
 D-82256 Fürstenfeldbruck  
 Germany  
 Tel: (81-41) 35-0  
 Telex: 527849  
 Fax: (81-41) 35-1

**National Semiconductor Japan Ltd.**  
 Sumitomo Chemical  
 Engineering Center  
 Bldg. 7F  
 1-7-1, Nakase, Mihama-Ku  
 Chiba-City,  
 Chiba Prefecture 261  
 Tel: (043) 299-2300  
 Fax: (043) 299-2500

**National Semiconductor Hong Kong Ltd.**  
 13th Floor, Straight Block,  
 Ocean Centre, 5 Canton Rd.  
 Tsimshatsui, Kowloon  
 Hong Kong  
 Tel: (852) 2737-1600  
 Fax: (852) 2736-9960

**National Semicondutores Do Brazil Ltda.**  
 Rue Deputado Lacorda Franco  
 120-3A  
 Sao Paulo-SP  
 Brazil 05418-000  
 Tel: (55-11) 212-5066  
 Telex: 391-1131931 NSBR BR  
 Fax: (55-11) 212-1181

**National Semiconductor (Australia) Pty. Ltd.**  
 Building 16  
 Business Park Drive  
 Monash Business Park  
 Nottingham, Melbourne  
 Victoria 3168 Australia  
 Tel: (3) 558-9999  
 Fax: (3) 558-9998

National does not assume any responsibility for use of any circuitry described, no circuit patent licenses are implied and National reserves the right at any time without notice to change said circuitry and specifications.