

# Reversible motor driver

## BA6209/BA6209N

The BA6209 and BA6209N are reversible-motor drivers suitable for brush motors. Two logic inputs allow four output modes : forward, reverse, idling, and braking. The motor revolving speed can be set arbitrarily by controlling the voltage applied to the motor with the control pin voltage  $V_a$ .

●Applications

VCRs and cassette tape recorders

●Features

- |  |   |
|--|---|
| 1) Power transistors can handle a large current (1.6A maximally).                | 5) Small standby current. ( $V_{CC}=12V$ , $I_o=5.5mA$ typically)                     |
| 2) Brake is applied when stopping the motor.                                     | 6) Stable operation during mode changes either from forward to reverse or vice versa. |
| 3) Built-in function to absorb rush currents generated by reversing and braking. | 7) Interface with CMOS devices.   |
| 4) Motor speed controlling pin.  |   |

●Block diagram

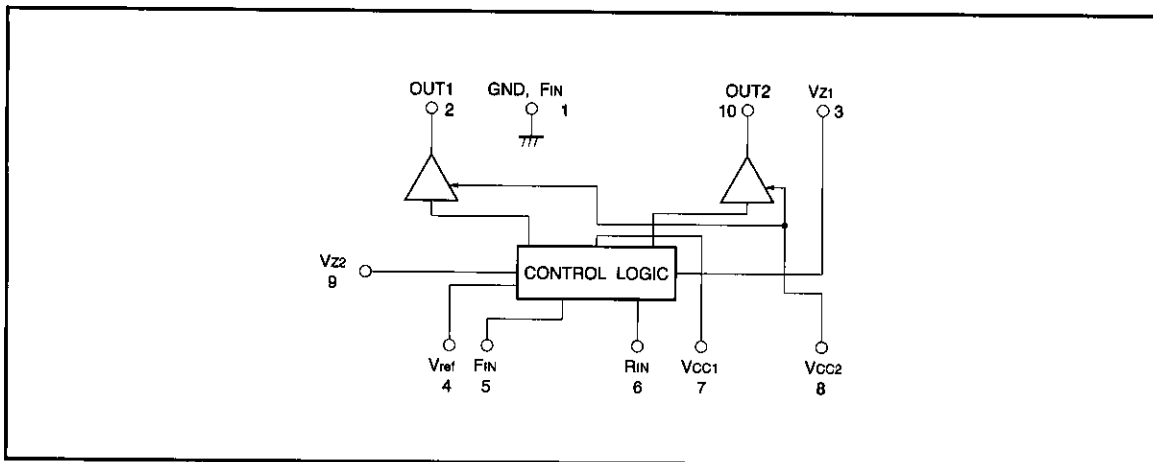

●Absolute maximum ratings (Ta=25°C)

Parameter	Symbol	Limits	Unit
Power supply voltage	V <sub>CC</sub>	18	V
Power dissipation	BA6209	2200*1	mW
	BA6209N	1000*2	
Output current	I <sub>O</sub>	1.6*3	A
Input voltage	V <sub>IN</sub>	-0.3~V <sub>CC</sub>	V
Operating temperature	T <sub>opr</sub>	-20~75	°C
Storage temperature	T <sub>stg</sub>	-55~125	°C

- \*1 Reduce power by 22 mW for each degree above 25°C.
- \*2 Reduce power by 10 mW for each degree above 25°C.
- \*3 500 μs pulse with a duty ratio of 1%.

●Recommended operating conditions (Ta=25°C)

Parameter	Symbol	Min.	Typ.	Max.	Unit
Operating power supply voltage 1 (Logic section)	V <sub>CC1</sub>	6.0	—	18.0	V
Supply voltage 2 (output section)	V <sub>CC2</sub>	—	—	18.0	V

●Electrical characteristics (unless otherwise noted, Ta=25°C and V<sub>CC</sub>=12V)

Parameter	Symbol	Min.	Typ.	Max.	Unit	Conditions
Current consumption	I <sub>CC</sub>	—	5.5	10	mA	F <sub>IN</sub> =R <sub>IN</sub> =GND, R <sub>L</sub> =∞
Minimum input ON current	I <sub>IN</sub>	—	10	50	μA	R <sub>L</sub> =∞
Input threshold voltage	V <sub>TH</sub>	0.7	1.2	2.0	V	R <sub>L</sub> =∞
Output leakage current	I <sub>OL</sub>	—	—	1.0	mA	F <sub>IN</sub> =R <sub>IN</sub> =GND, R <sub>L</sub> =∞
Output voltage	V <sub>O</sub>	6.6	7.2	—	V	R <sub>L</sub> =60Ω, Z <sub>D</sub> =7.4V

●Electrical characteristic curves

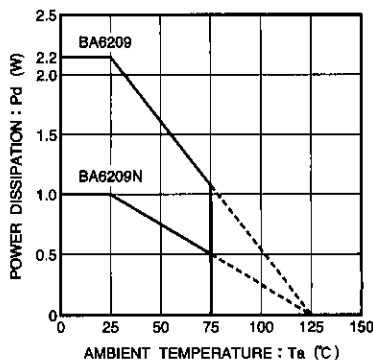

Fig.1 Temperature dependence power dissipation curves

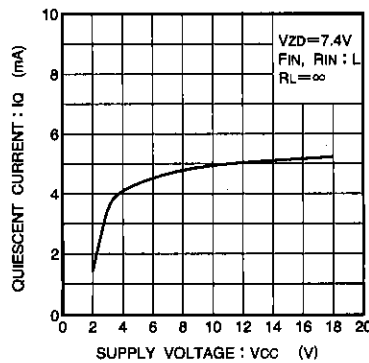

Fig.2 Quiescent current vs. power supply voltage

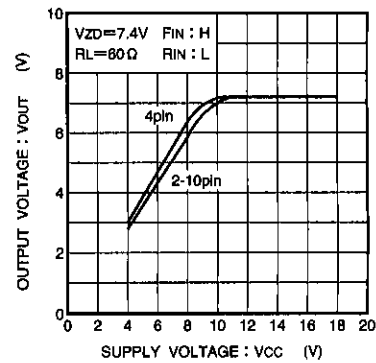

Fig.3 Maximum output voltage vs. power supply voltage ( I )

● Electrical characteristic curves

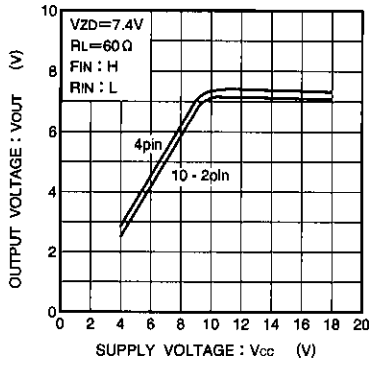

Fig.4 Maximum output voltage vs. power supply voltage (II)

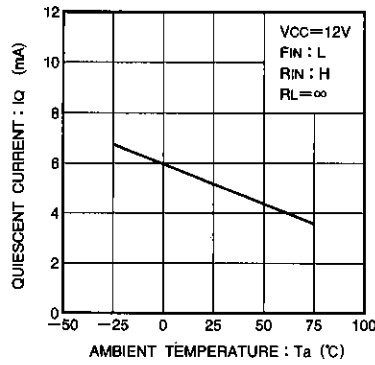

Fig.5 Quiescent current vs. ambient temperature

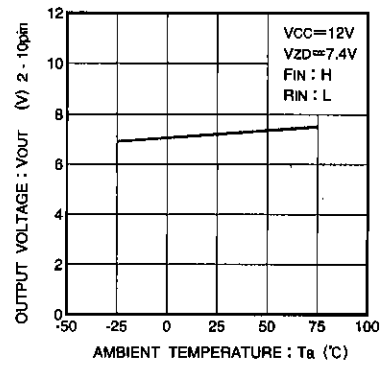

Fig.6 Output voltage vs. ambient temperature (I)

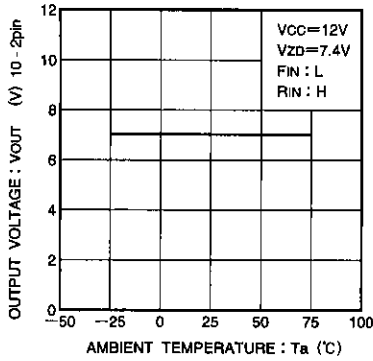

Fig.7 Output voltage vs. ambient temperature (II)

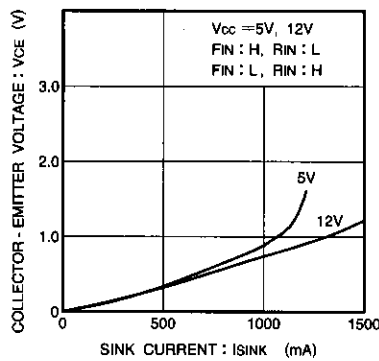

Fig.8 Output saturated voltage vs. sink current (I)

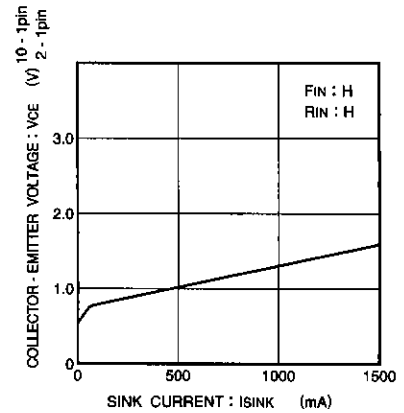

Fig.9 Output saturated voltage vs. sink current (II)

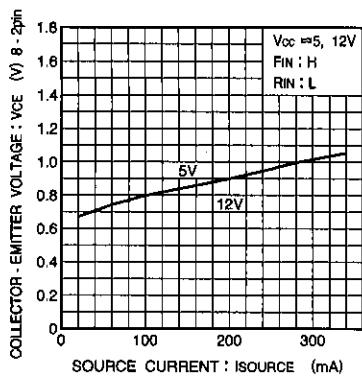

Fig.10 Output saturated voltage vs. source current (I)

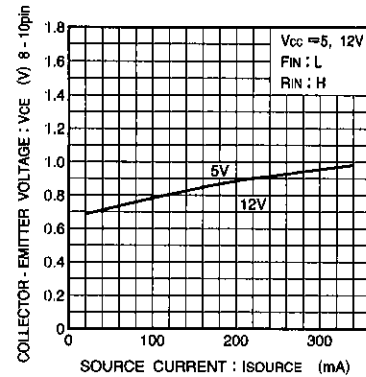

Fig.11 Output saturated voltage vs. source current (II)

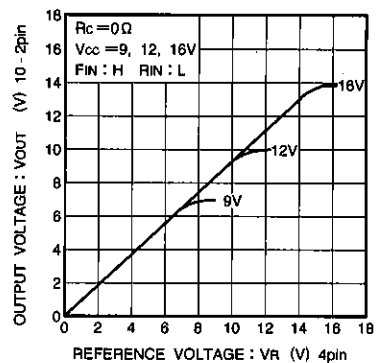

Fig.12 Output voltage vs. reference voltage (I)



## ●Circuit operation

## Input/output truth table

Input		Output	
F <sub>IN</sub>	R <sub>IN</sub>	OUT1	OUT2
L	L	L	L
H	L	H	L
L	H	L	H
H	H	L	L

Forward/reverse control, forced stop, and rush current absorption are controlled by the combination of F<sub>IN</sub> and R<sub>IN</sub> input states.

## (1) Forward/reverse control circuit

When F<sub>IN</sub> is HIGH and R<sub>IN</sub> is LOW, current flows from OUT1 to OUT2. When F<sub>IN</sub> is LOW and R<sub>IN</sub> is HIGH, current flows from OUT2 to OUT1 (refer to the truth table).

## (2) Forced stop circuit

By setting R<sub>IN</sub> and F<sub>IN</sub> both HIGH or both LOW, power supply to the motor is shut down and a brake is applied by absorbing the motor counter-electromotive force.

## (3) Rush current absorption circuit

When a high voltage (caused by such as a motor reversal) is generated on OUT1 and OUT2, an internal comparator detects the high voltage and turns on an internal circuit that absorbs rush currents.

## (4) Drive circuit

The forward direction of the motor connected between OUT1 and OUT2 corresponds to the current flow from OUT1 to OUT2, and the reverse direction corresponds to the current flow from OUT2 to OUT1. The output voltage (V<sub>OUT</sub>) applied to the motor is given by the equation :

$$V_{OUT} (V) = V_{ZD} - V_{CE} (sat.) = V_{ZD} - 0.2 (I_{OUT} = 100mA)$$

where V<sub>ZD</sub> is the zener voltage of the constant voltage diode (ZD) connected to pin 4.

If V<sub>REF</sub> is left OPEN, the output voltage (V<sub>OUT</sub>) is given by the equation :

$$V_{OUT} (V) = V_{CC1} - V_{CE} (sat.) (PNP) - 2V_F - V_{CE} (sat.) \\ = V_{CC1} - 1.8 (I_{OUT} = 100mA)$$

## ●Pin description

Pin No.	Pin name	Function
1	GND	GND
2	OUT 1	Motor output pin
3	V <sub>Z1</sub>	Capacitor connection pin for preventing both output transistors being turned on at the same time
4	V <sub>ref</sub>	Output HIGH voltage setting pin
5	F <sub>IN</sub>	Logic input pin
6	R <sub>IN</sub>	Logic input pin
7	V <sub>CC1</sub>	Control circuit power supply pin
8	V <sub>CC2</sub>	Output power supply pin
9	V <sub>Z2</sub>	Capacitor connection pin for preventing both output transistors being turned on at the same time
10	OUT 2	Motor output pin

● Operation notes

(1) Resistor dividing IC power consumption

To reduce power dissipated in the IC, a resistance (about 3 ~ 10Ω) must always be connected between V<sub>CC</sub> and the power supply pin of the driver circuit. If V<sub>CC2</sub> is connected to V<sub>CC</sub> with no resistor, the IC can be damaged by overcurrent when operated at the voltage range close to the maximum operating voltage.

(2) Control signal waveform

The rise and fall times of signals applied to the control pins should be 5ms or less. Longer times can cause erratic operation of the internal logic circuits and may result in damage to the driver circuits.

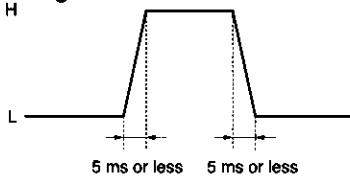

Fig.17 Control signal

For example, if the supply voltage for the external control circuit comes up after the supply voltage of the IC, the rising edge of the control signal slowly follows the rise of the external supply voltage. This could result in erratic operation or damage to the IC due to excess currents.

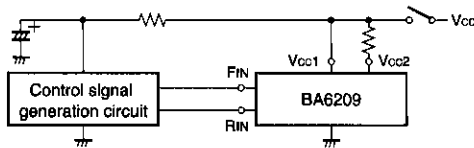

Fig.18

(3) IC ground voltage

To provide separation between the circuit elements within the IC, the GND pin of the IC must always be held at a lower potential than the other pins.

If the potential of the GND pin is allowed to rise above that of other pins (such as the control input pins), separation between the internal circuit elements could break down, resulting in erratic operation or internal damage.

For example, a resistor may be connected between GND (pin 1) and the ground as shown in Fig. 19, when detecting and controlling the motor operating current. In this case, the potential of pin 1 would be above the ground potential by an amount equal to the voltage drop across the resistor. Therefore, dropping the input pin potential to the ground potential would have the effect of applying a negative voltage to the input pin.

This should be avoided by detecting the motor operating current in a way shown in Fig. 20.

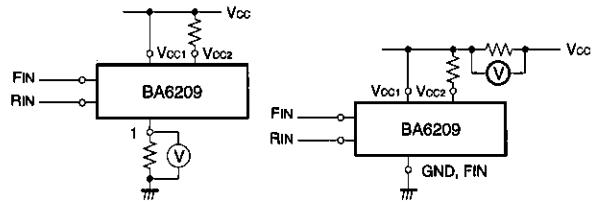

Fig.19

Fig.20

(4) V<sub>CC</sub> pin capacitor and conductor pattern design

Because a large instantaneous current up to 1 ~ 2A flows in the BA6209 and BA6209N ICs during motor startup and rotational reversing, special care must be taken in designing power supply and conductor patterns. If the conductor lines on the PCB are made too narrow with a high DC resistance, a voltage drop from a few hundred millivolts to a few volts can occur across the foil. This leads to a higher potential at the GND pin than the ground potential, and can result in erratic operation or damage as previously described.

The same is also true for the supply voltage lines. The design must ensure that large current pulses do not result in voltage fluctuations on the supply lines. To avoid these problems, the following precautions should be observed :

- 1) Make conductor lines as thick as possible, and suppress the occurrence of high voltage by reducing the DC resistance of the conductor runs through which large currents flow.
- 2) To avoid common impedance, provide adequate physical separation between input and output circuits.
- 3) The bypass capacitor between the V<sub>CC</sub> and GND pins should be placed as close as possible to both pins.

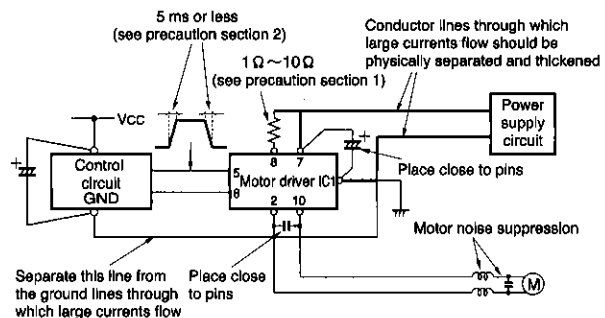

Fig.21

●Application example

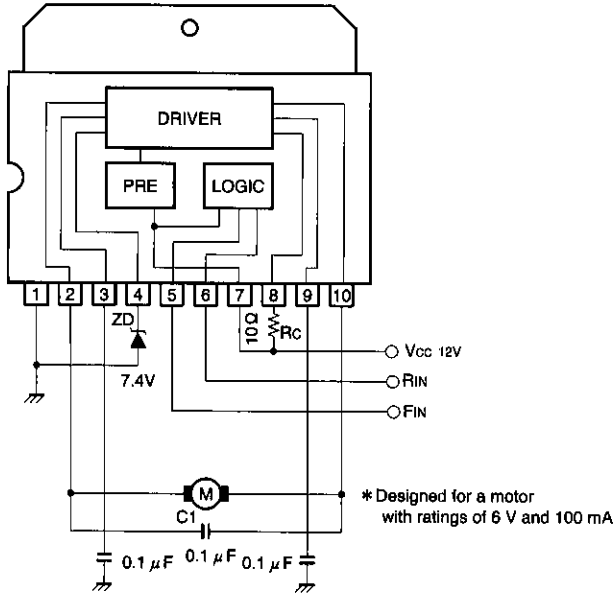

Fig.22

●External dimensions (Units: mm)

